





# Champions – A Question of Perspective



**Germany**

**Total Installed PV Capacity – 38,200 MW**

**China**

**Total Added PV Capacity – 10,560 MW**

**Bangladesh**

**No. of Households Equipped with PV Systems – 3,5 Mio.**







# Sustainable & Inclusive Energy Solutions

Noara Kebir  
Managing Director

*14<sup>th</sup> September 2015, New York*



# Agenda



**Who we are**



**What we do**



**How we do it**



**Key challenges**

# Who We Are



**Team of 35  
Members**

**Consulting for end-user Energy Solutions  
Communication and Management  
Interdisciplinary Competences**

**105 Support  
Consultants**

**Engineering      Software      Business  
administration      ITC      Financial  
Instruments**

**Energy  
Economics      Statistics      Marketing      Microfinance**

**50 Partner  
Institutions**

**Academic  
Institutions      Financial  
Institutions      Development  
Institutions**

# What We Do

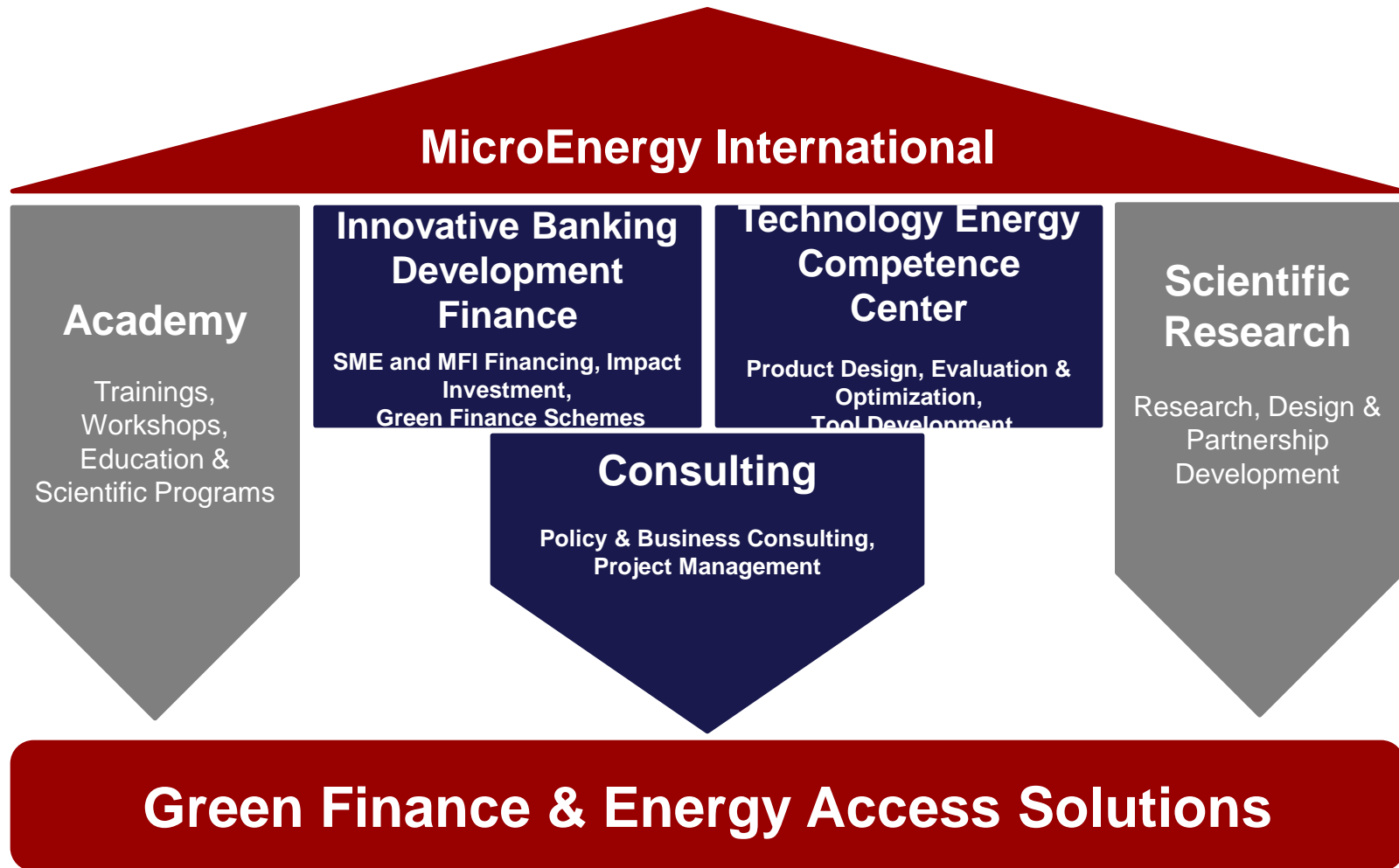

# MEI Activities





# Linking Financial and Energy Inclusion

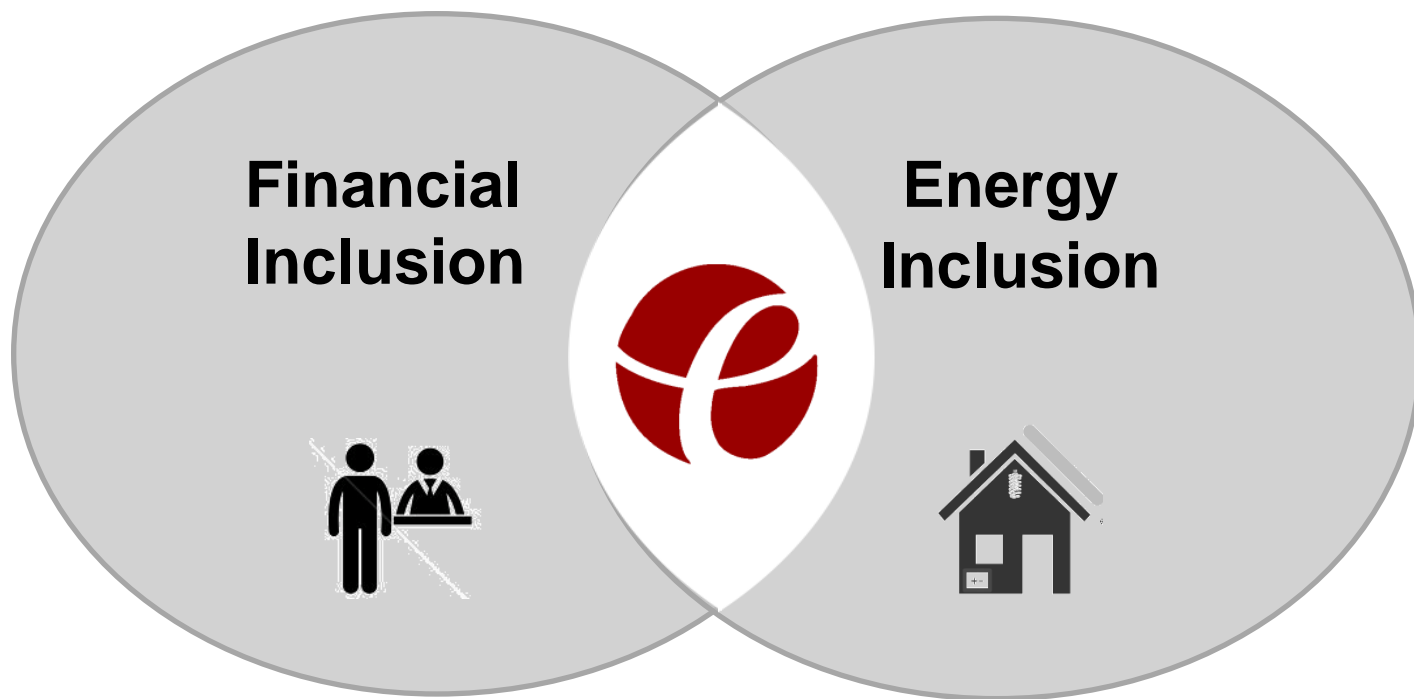

Initiatives such as SEWA, PACT, EcoFuel ...

# What We Do



## Financial Inclusion

## Energy Inclusion

## Green Finance

## Smart Engineering

- Institutional assessment
- Green loan design
- Business and operational models

- Energy needs assessment
- Technology R&D, validation
- Supply chain analysis



**Incubation**

**Financial  
Solutions**

**Scientific  
Research**

**Technical  
Assistance**

**Smart  
Solutions**

**Academy**

# Linking Financial and Energy Inclusion

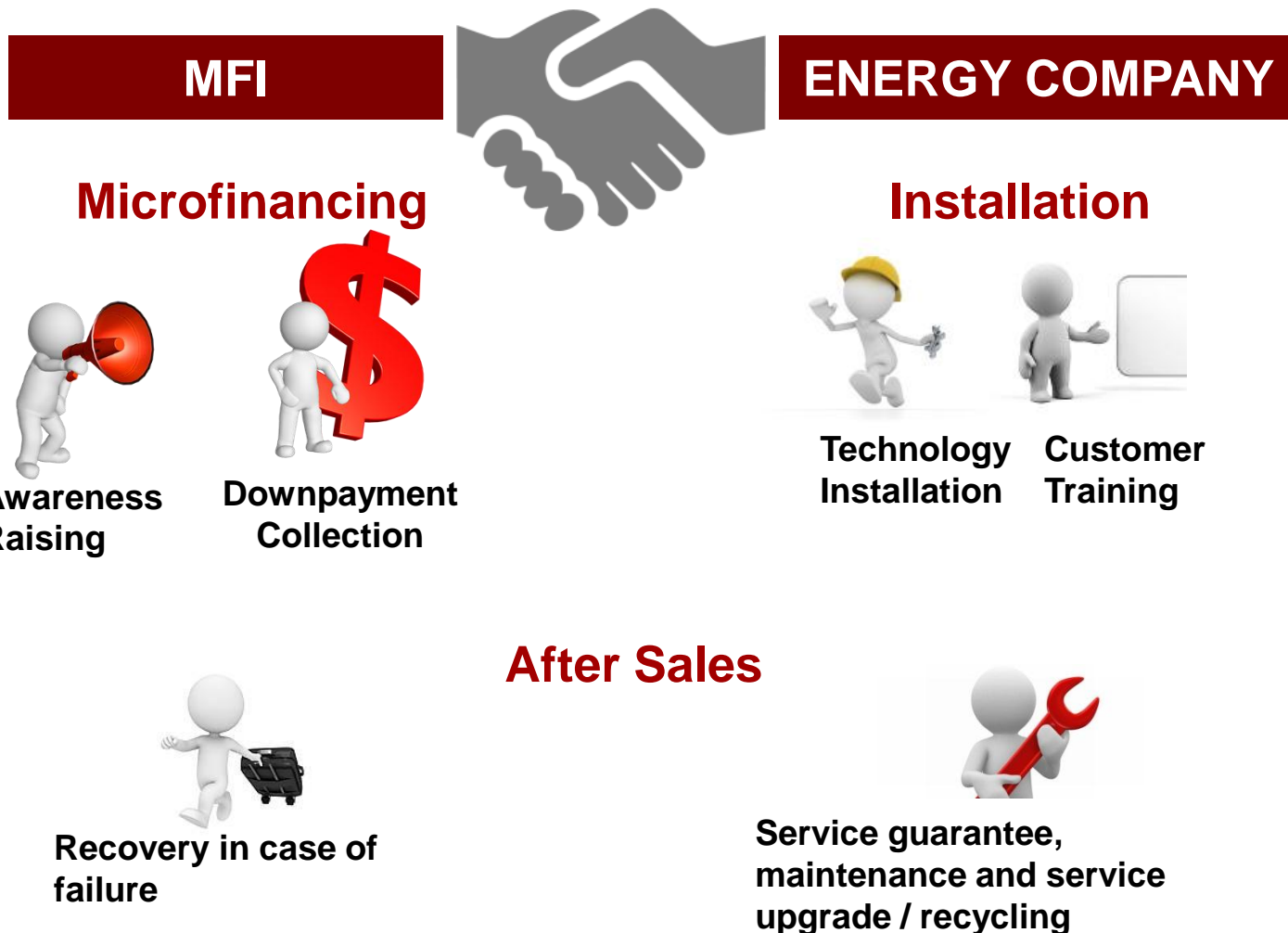



# Energy Inclusion Initiative



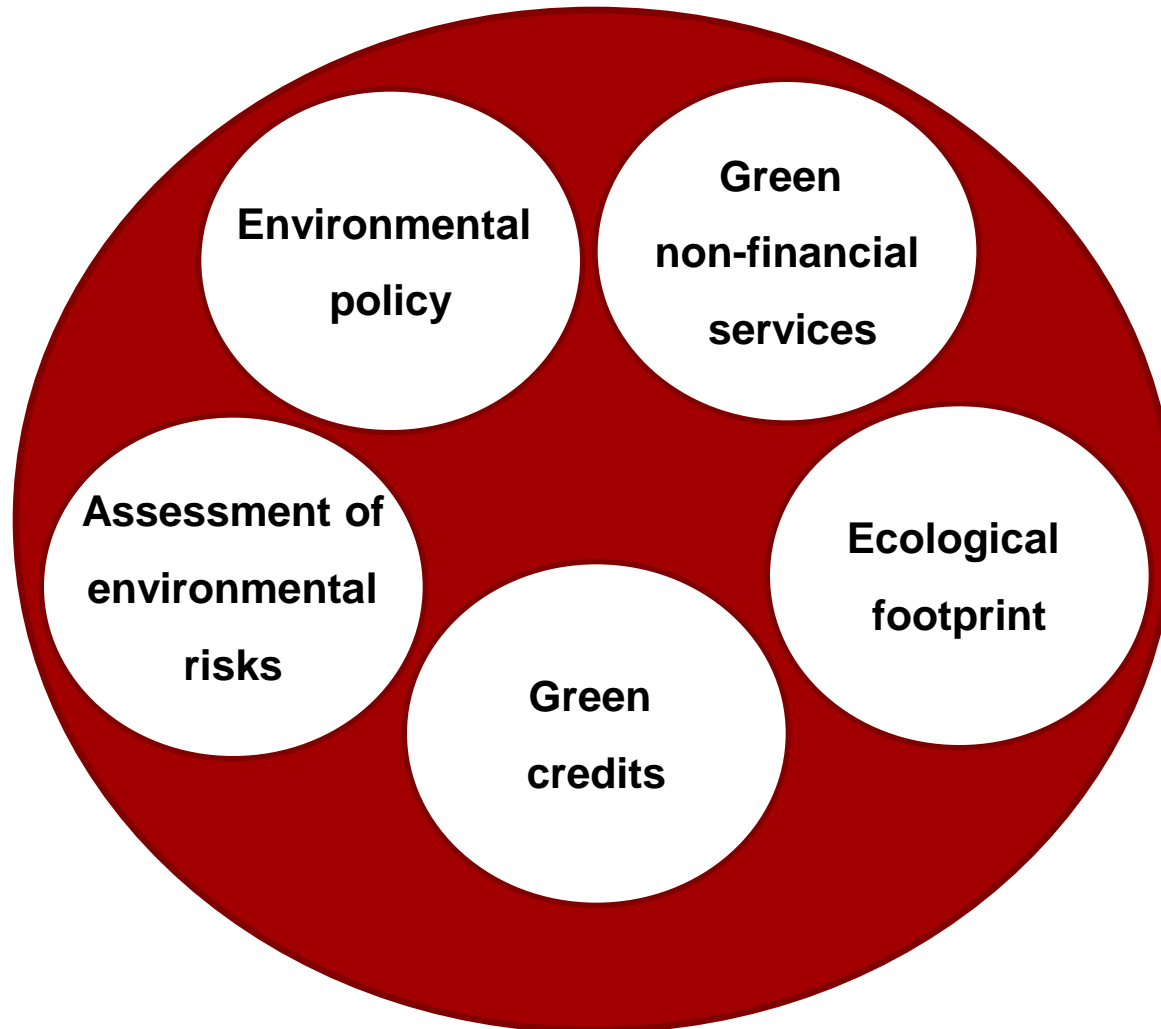

# Engineering Smart & Inclusive Energy Concepts

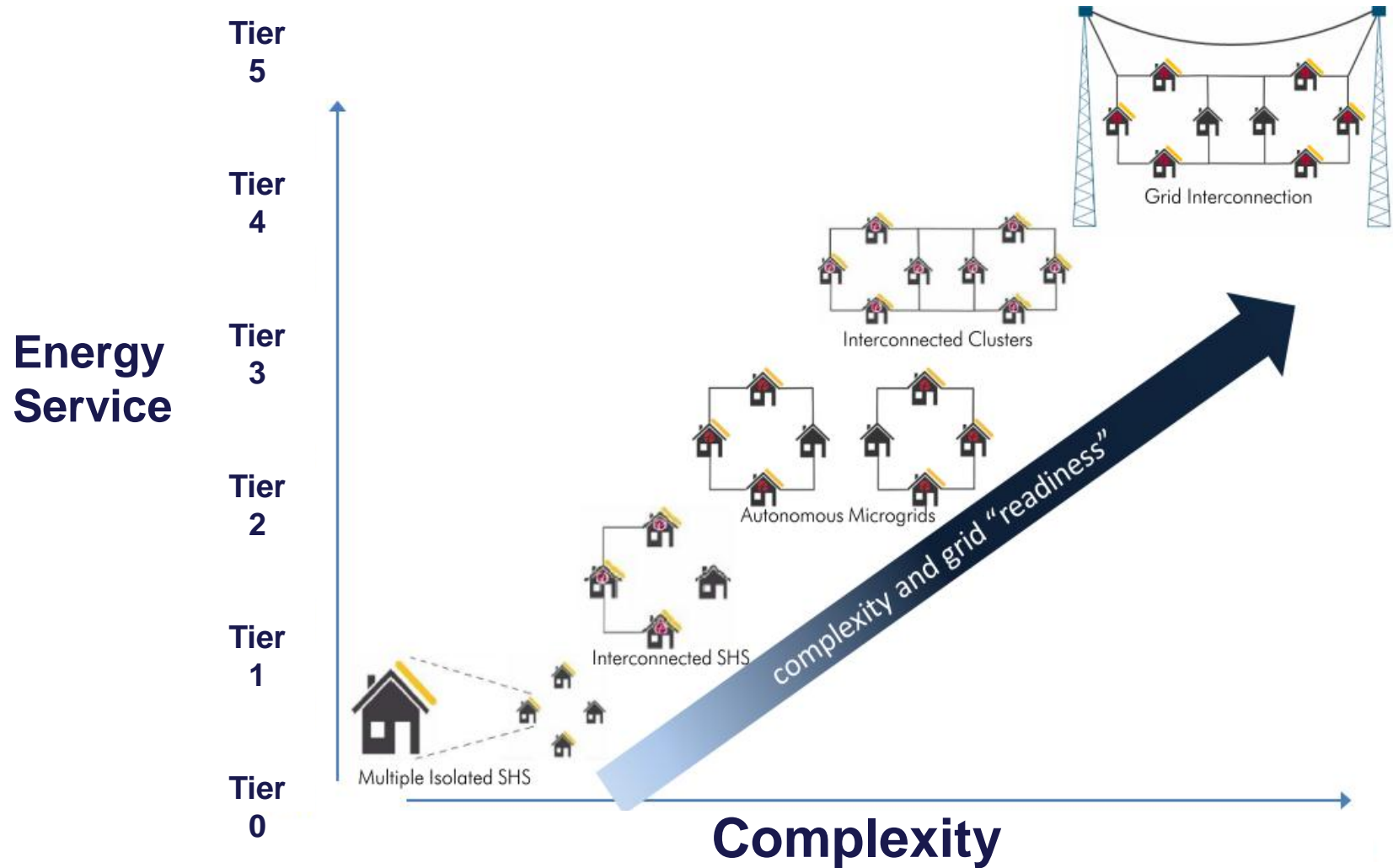



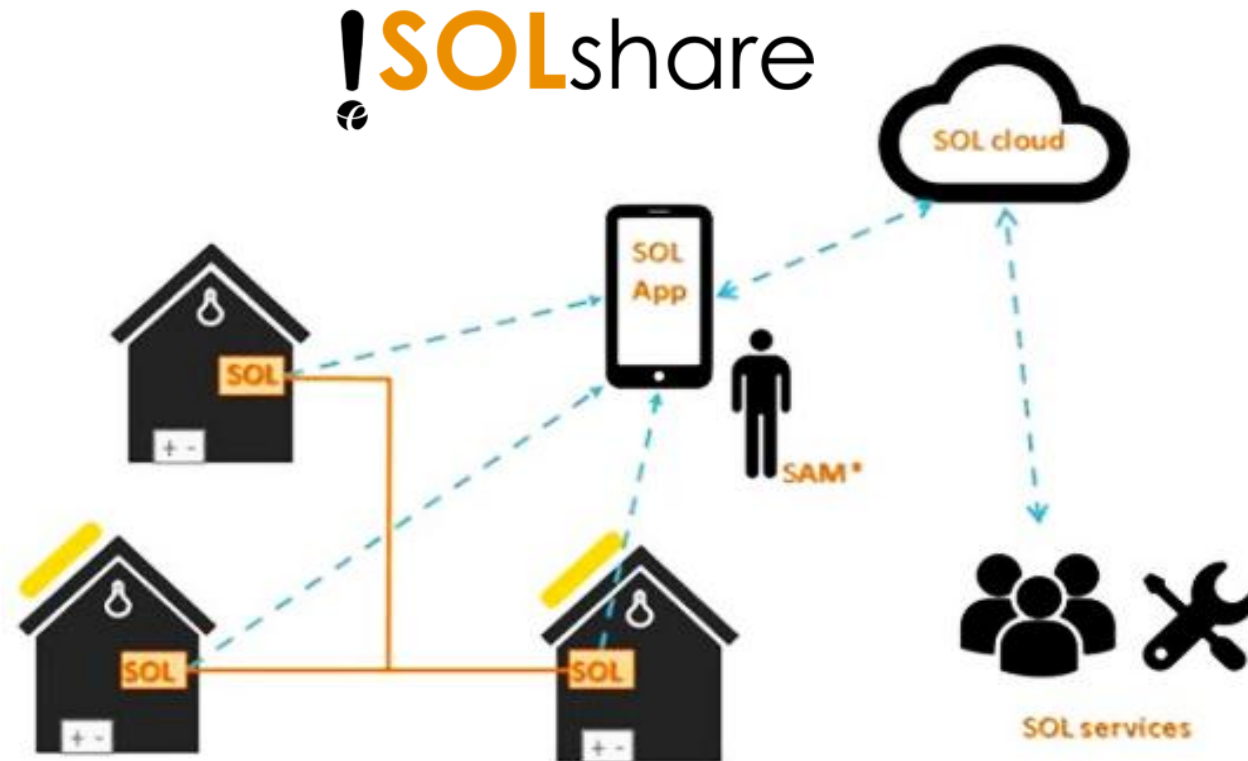

## Dynamic bottom-up DC micro-grids



**Off-grid DC appliances distributor**

# Scientific Research



- 16 PhDs
- 4 international conferences
- 80 Students Graduations

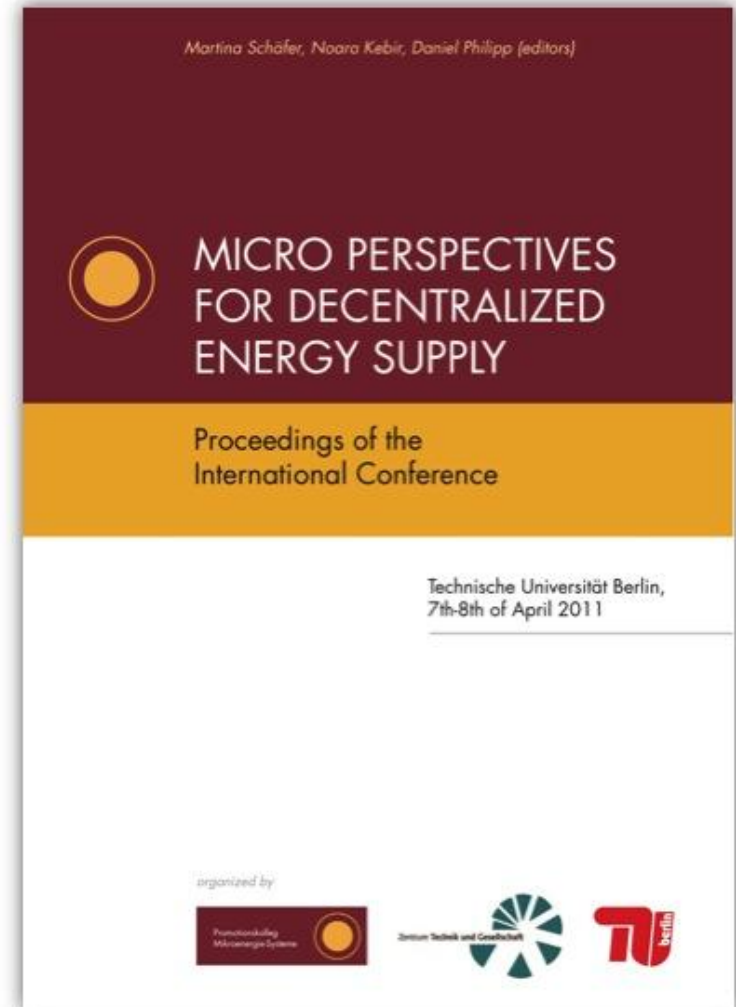



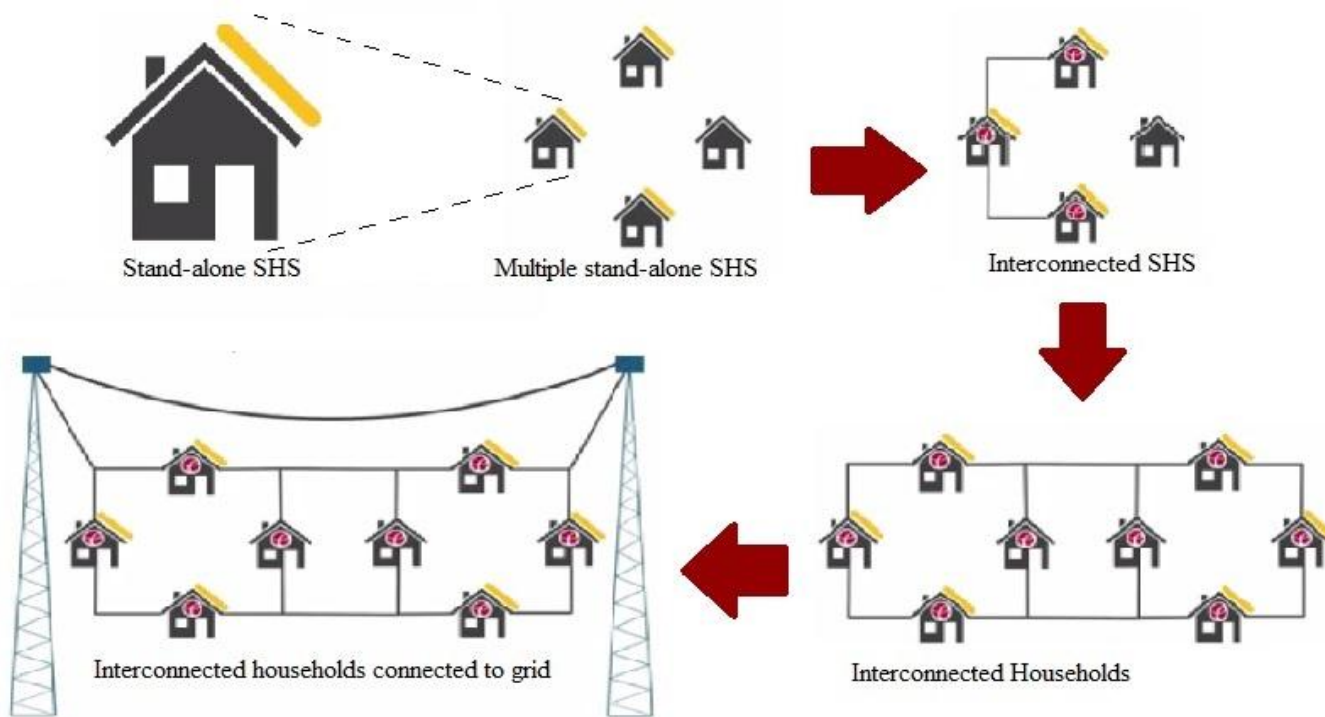

**Swarm Electrification**  
**Make Yourself Connectable to the Future!**



- Training and qualifying of energy and finance professionals
- Regular university courses
- Workshops
- Vocational trainings



# Key Challenges



## Technical

- Quality assurance of products and services
- Presence and outreach of local validated suppliers

## Managerial

## Financial

# Key Challenges



Technical

Managerial

- Intrinsic motivation of key stakeholders
- Development of smart incentives along the supply chain

Financial



# Key Challenges



Technical

Managerial

Financial

- Financing of local SMEs along the supply chain



**Let's Swarm Together!**

**Thank you for  
your attention!**

**MicroEnergy International**

Potsdamer Str. 143

10783 Berlin, Germany

**Noara.Kebir@microenergy-international.com**



[www. microenergy-international.com](http://www.microenergy-international.com)



# Back Up Slides



# Internet link swarm video

<https://www.youtube.com/watch?v=C-9CINpZr34>

## [Local link swarm video](#)

# Daniel TEDex

<https://www.youtube.com/watch?v=rn57rdrLlK4>

# Swarm Grid

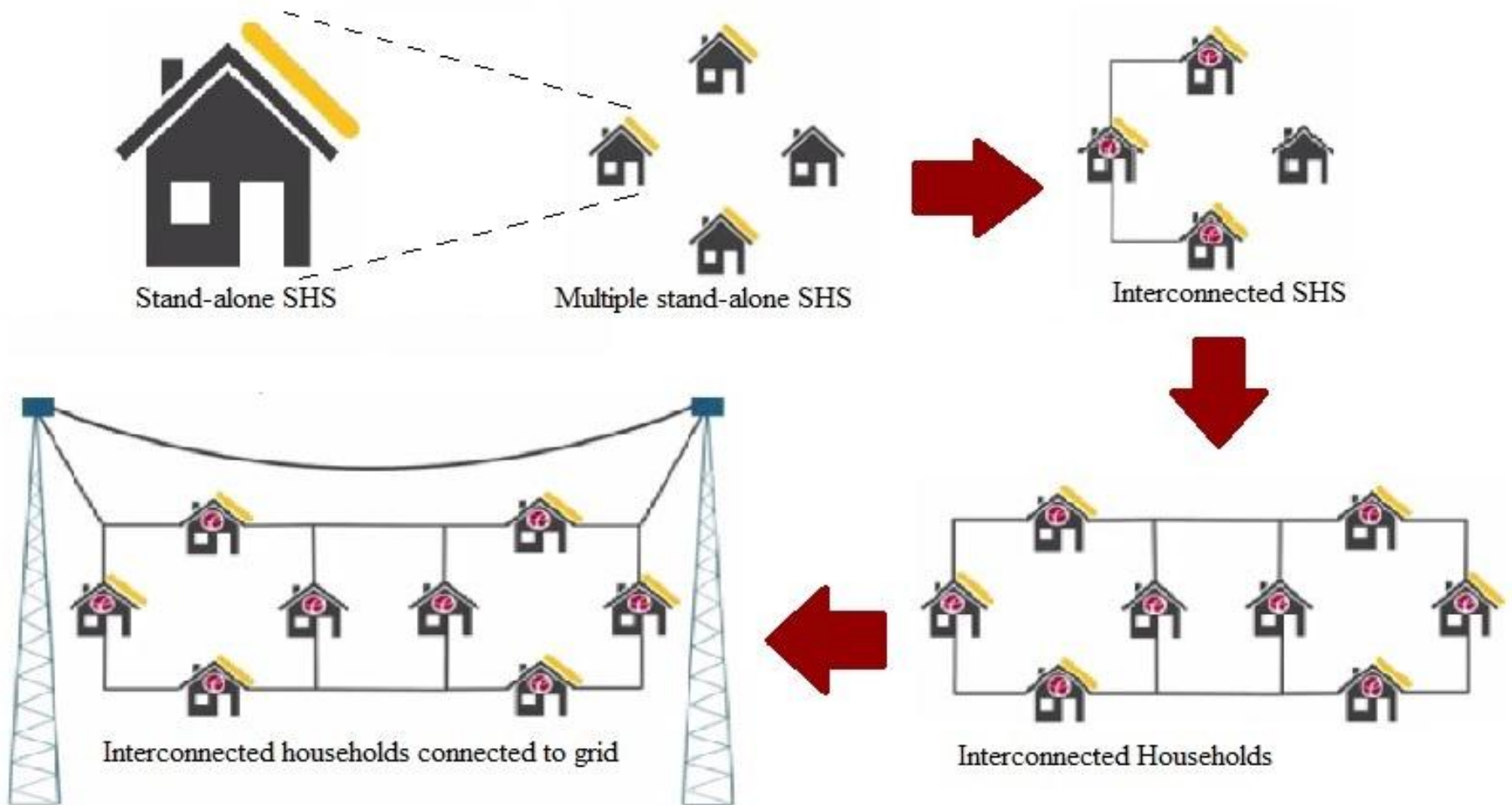

# Sustainable Energy Access for All



70% of SE4ALL Goal (1.3B)

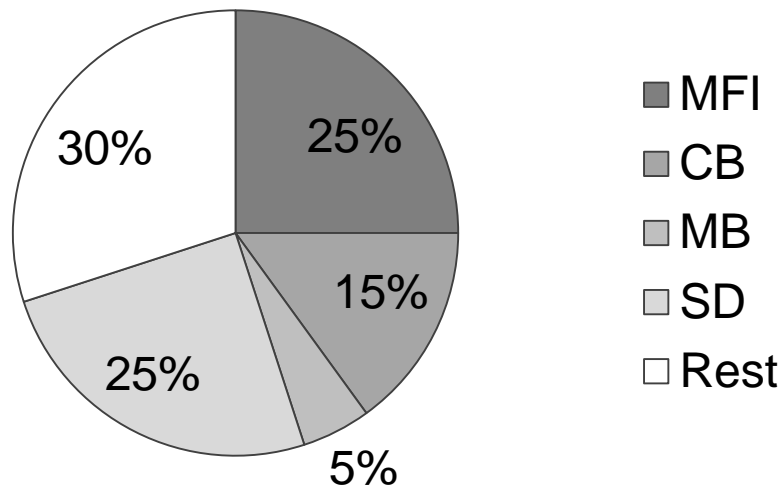

56% of MEI Goal (1.6B)

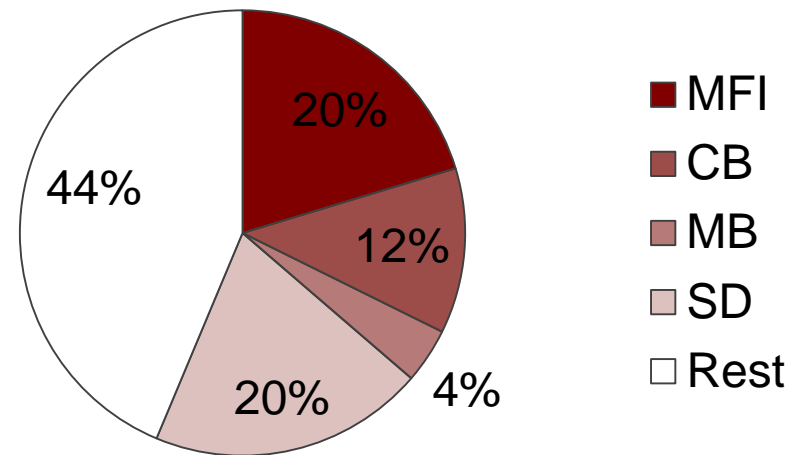

# Linking Financial and Energy Inclusion

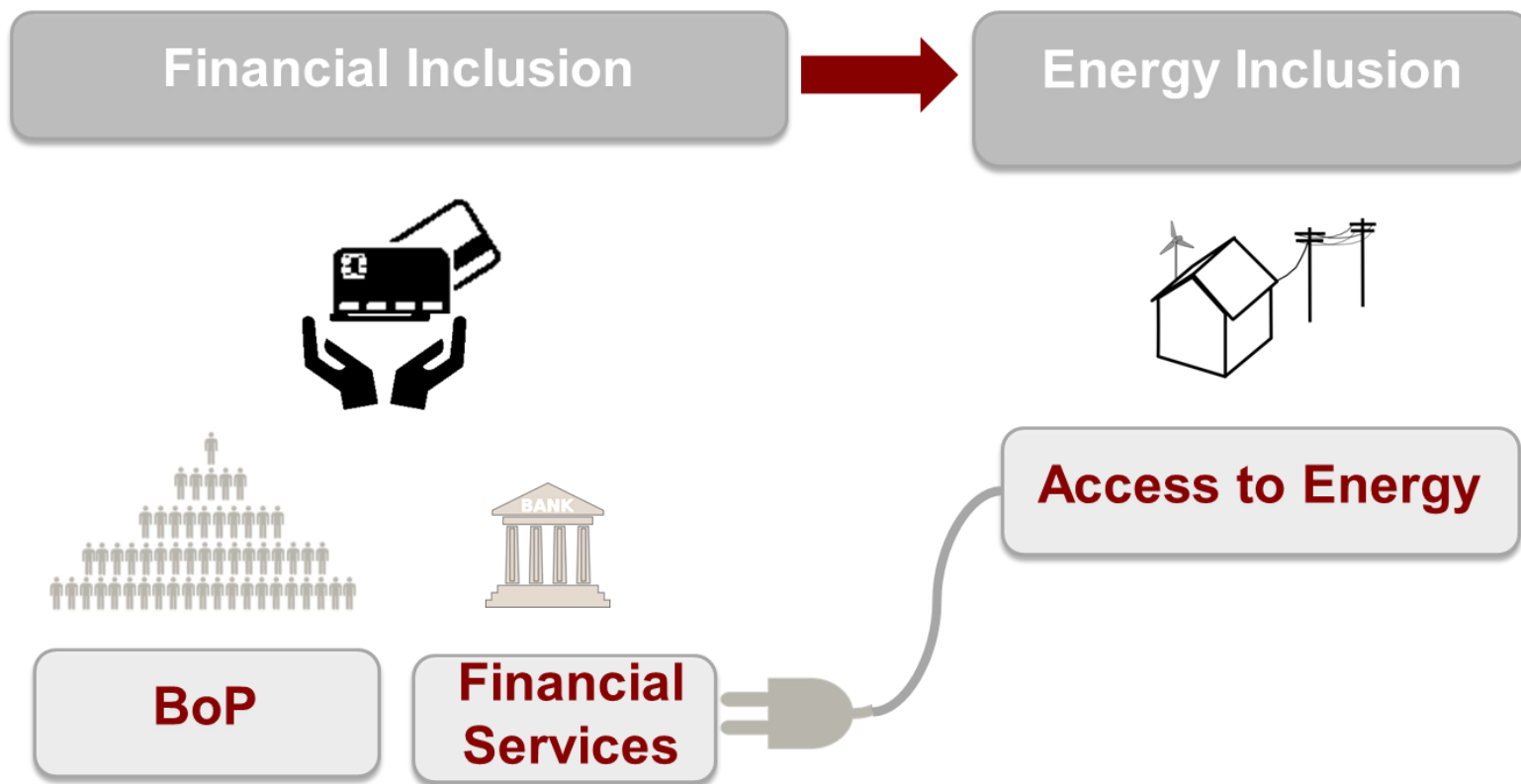



# Swarming Microfinance

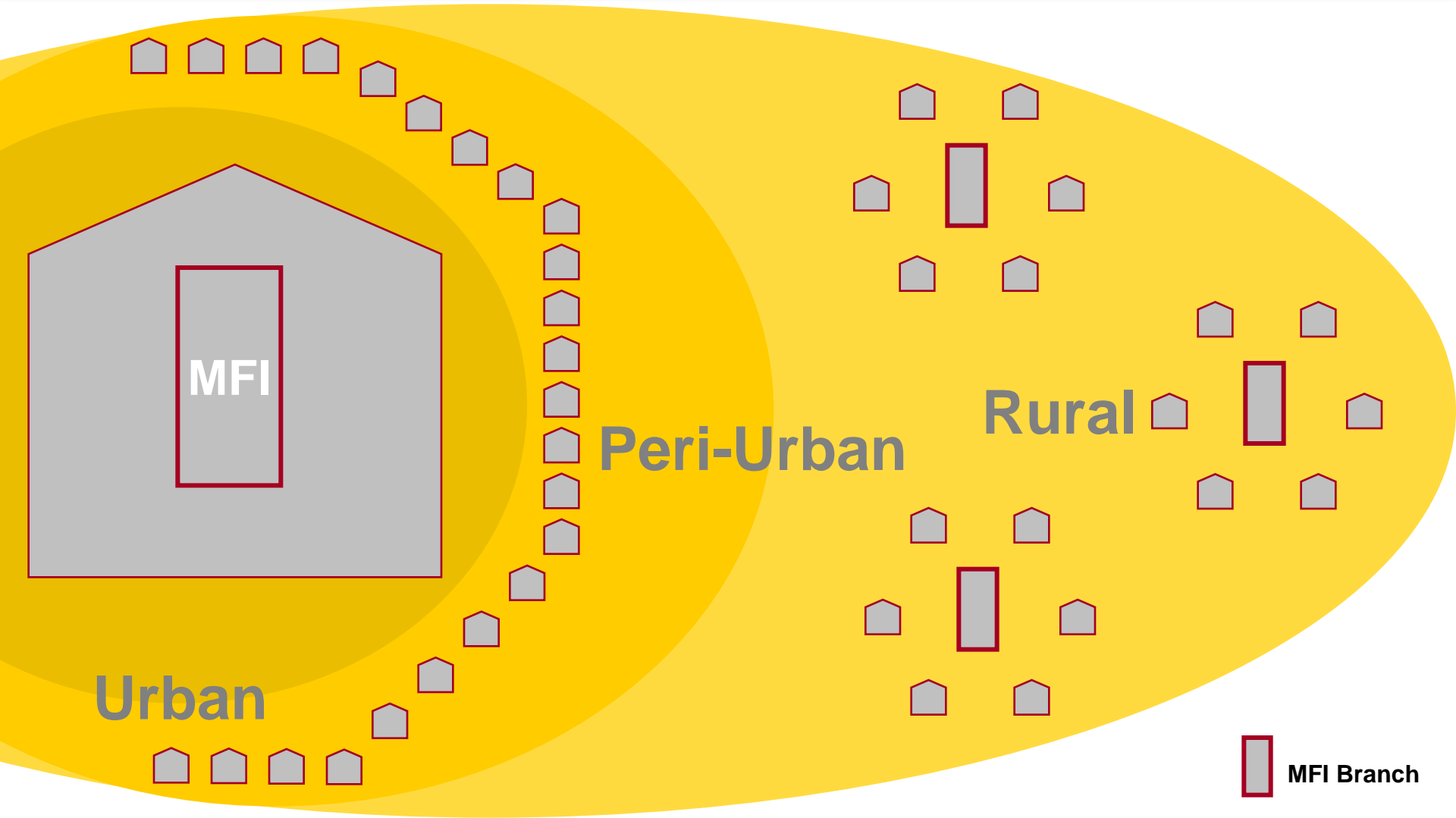

# Swarming Microfinance

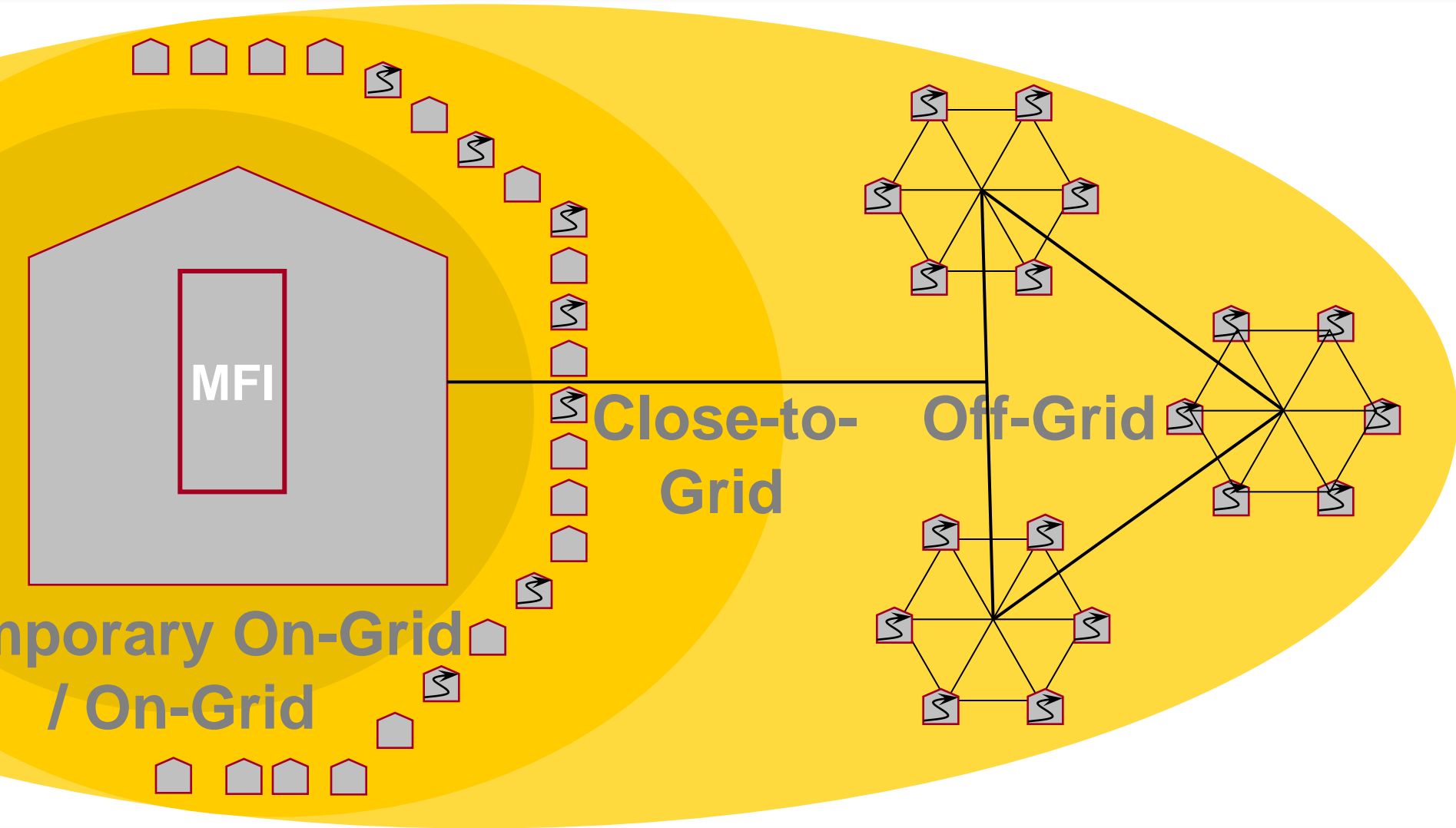

# Technical Assistance

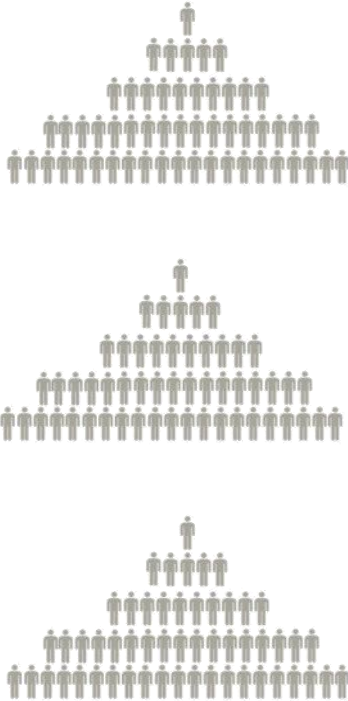

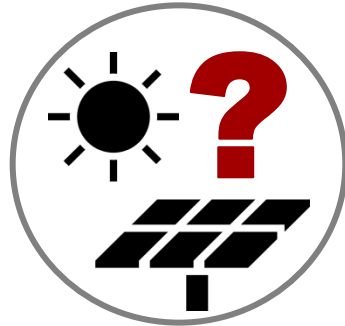

**Technology Selection**



**Supplier Selection**



**Green Credit Product**